

UFH Wiring Centre

WWC-09

Installation manual



Warmup[®]

The world's best-selling floor heating brand[™]

Over 2.7 million installations
in more than 72 countries

Experience MyHeating[™]

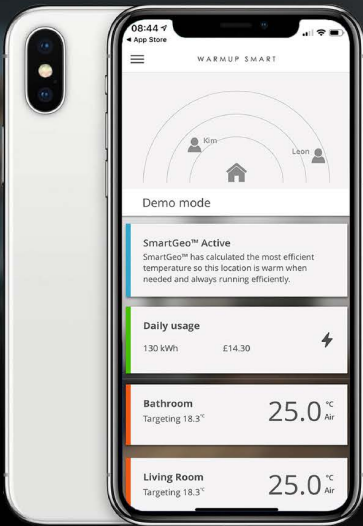

SmartGeo[™]

Unique SmartGeo[™] automatically turns down the heating when you're out.



Easy to use

Simple and secure setup using WiFi, with 24/7 technical support.



AutoSwitch[™]

Always on the best tariff, automatically. **Reduce energy bills by over £400**

Download now for iOS and Android



6iE OB WiFi Thermostat



Table of contents

Installation summary	4
Important information	6
Components available from Warmup	7
Overview	8
Dimensions	10
Delayed start, zone valve bridge and test switches	11
Step 1 - Location considerations	12
Step 2 - Assembly & mounting	13
Step 3 - Wiring	
Power supply.....	14
Combined power supply & heat source	15
Heat source	16
Thermostat & actuators.....	18
Circulator	20
UFH zone valve	21
Hot water	22
Radiators	23
Schematics	
Wiring schematic - Typical installation	24
Plumbing schematic - Typical installation	26
Troubleshooting	28
Performance troubleshooting	35
Technical specifications	36
Warranty	38

This product uses mains voltage electricity and work should only be carried out by a qualified electrician. You should always isolate the power supply before attempting to install or repair the Wiring Centre or connected devices. The Wiring Centre should not be put into operation unless you are certain that the entire heating installation has been completed in accordance with latest IEE Wiring Regulations and appropriate statutory Regulations.

It is important that before, during and after installation that all requirements are met and understood. If the instructions are followed, you should have no problems. If you require help at any stage, please contact our helpline.

You may also find a copy of this manual, wiring instructions and other helpful information on our website:

www.warmup.co.uk

Installation summary

Please read the full installation instructions before proceeding.

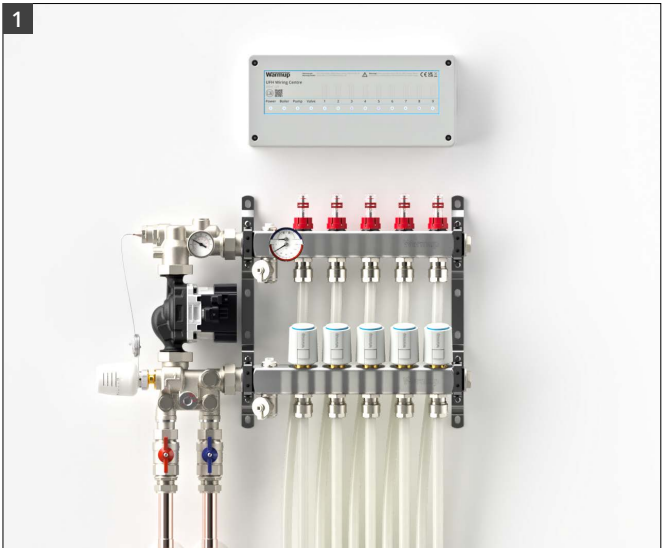

- Identify a suitable mounting location. Normally above the manifold.



- Remove the front cover of the Wiring Centre and mark the screw positions on the mounting surface.



- Drill the pre-marked holes and insert a suitable wall plug (if required).

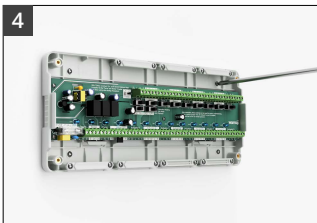

- Screw the Wiring Centre to the wall using M4x30mm screws.



- If Wiring Centre is being DIN rail mounted, hook onto the rail and click in place.

Installation summary







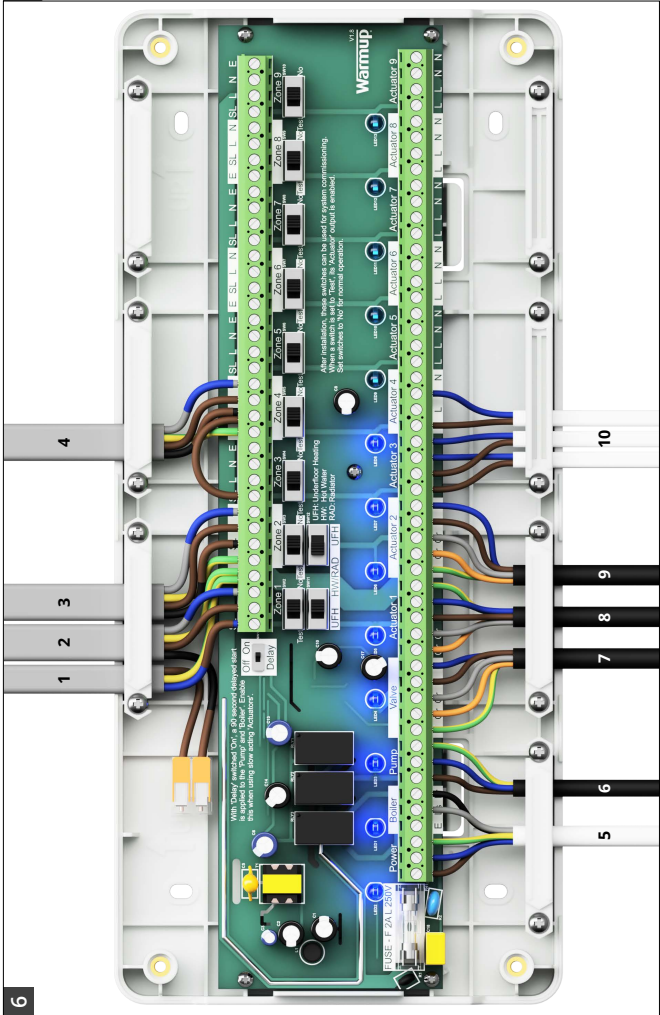

Do not switch on the power supply until all wiring connections have been terminated and front cover re-fitted.

Legend

- 1 Cylinder thermostat
- 2 Single channel programmer
- 3 Radiator thermostat
- 4 UFH Thermostat (Shown with 2 zones bridged)
- 5 Power supply and interlock (5-core HR Flex) 230V AC; 50Hz
- 6 Circulator
- 7 UFH zone valve (optional)
- 8 Hot water zone valve
- 9 Radiator zone valve
- 10 UFH actuators



Important information

-  Ensure the Wiring Centre is mounted to a structurally sound wall.
-  Precautions should be taken to reduce the risk of damaging any services within the walls when drilling.
-  Ensure no loose strands wire are left outside of the terminal blocks during wiring.
-  Ensure the wires are fully inserted into the terminals before tightening.
-  Ensure the Wiring Centre is connected to the same supply circuit as the rest of the heating system, so as to keep everything to a single point of isolation.
-  Do not exceed specification - failure to do so will void the warranty.
-  Do not use excessive force when tightening screw terminals.

Components available from Warmup

Product Code	Description
Wired controls	
WWC-09	Warmup UFH Wiring Centre - 9 Zone Wiring Centre
6IE-01-OB-DC 6IE-01-BP-LC	Warmup 6iE
RSW-01-WH-RG (ELM-01-WH-RG) RSW-01-OB-DC (ELM-01-OB-DC)	Warmup Element
ELT PW (ELT-01-PW-01) ELT PB (ELT-01-PB-01)	Warmup tempo
Manifold components	
WHS-M-S3-XX	Warmup S3 Manifold <i>XX = No. of ports; 2-12</i>
WHS-M-S3-MIX	Mixing Unit - For S3 Manifold with 3 port valve - Capillary thermostat - Grundfos UPM3 circulator
WHS-M-S3-VALVES	1" Isolation valves (pair) - For S3 Manifold - 1" M Union to 22mm compression
WHS-M-S3-ACT230	230V Electrothermic actuator
Additional components	
WHS-ZONE VALVE 2 PORT	2-Port Zone Valve

Overview

Installation manual QR-Code

Links to landing page for country specific manuals

Captive case screws x 4

Prevents lost screws

Warmup
UFH Wiring Centre
WWC-09

Warmup plc 704 Tudor Estate, Abbey Road, London, N
Warmup GmbH Ottostraße 3, 27793 Wildenhausen, DE



Power Boiler Pump Valve 1 2

90 second delayed start function

Allows time for slow acting actuators to fully open

Wall mounting location x 4

Includes 4 wall screws & plugs (+ extra set)

LED indicators

Shows each output(s) activity for easier diagnostics

Fuse

F 2A L 250V (+ 1 extra)

Power supply terminals

230 V AC; 50Hz

Heat source terminals

Circulator terminals

Zone valve terminals

Remove zone valve bridge if connecting a zone valve

Zone valve bridge

Room name markers
Allows each zone to be labelled during installation

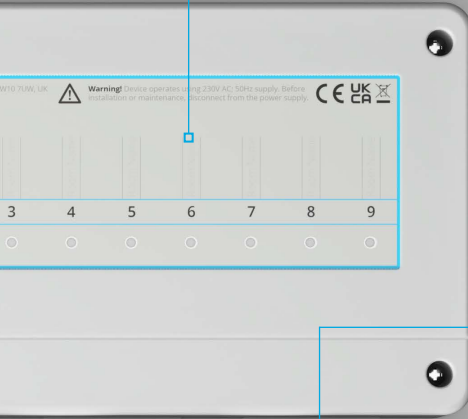

Reversible cable strain relief clamps x7

Zones 1-9 thermostat / programmer terminals

Thermostat connections for underfloor heating / radiators or programmer for hot water

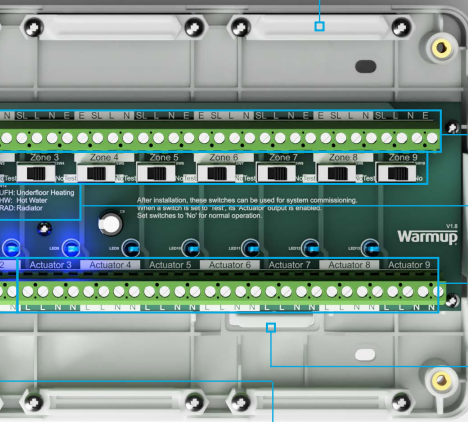

Zone 1/2 mode selects

Switch between underfloor heating, hot water / radiator

Actuator 3-9 terminals

For connection to underfloor heating actuators

Actuator 1/2 terminals
Can be used to control underfloor heating, hot water / radiator circuits

DIN rail clips x2

Zone test switches
Simulates a call for heat in this zone to check the status of the actuator, valve, circulator and heat source

Dimensions

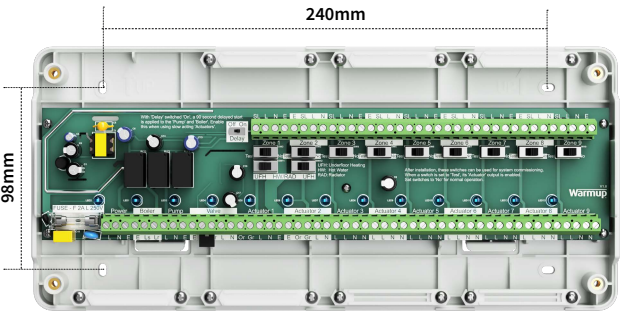
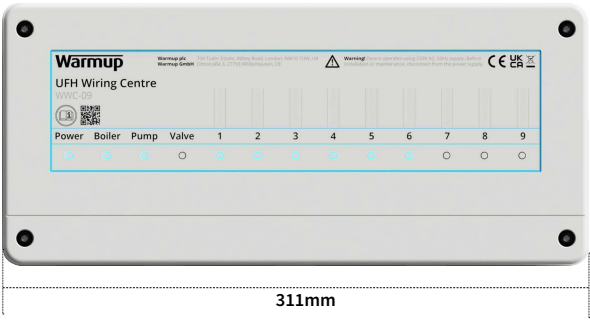
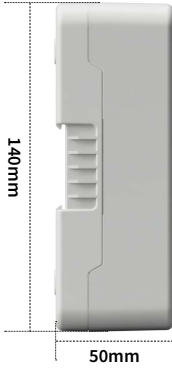

Step 1 - Location considerations

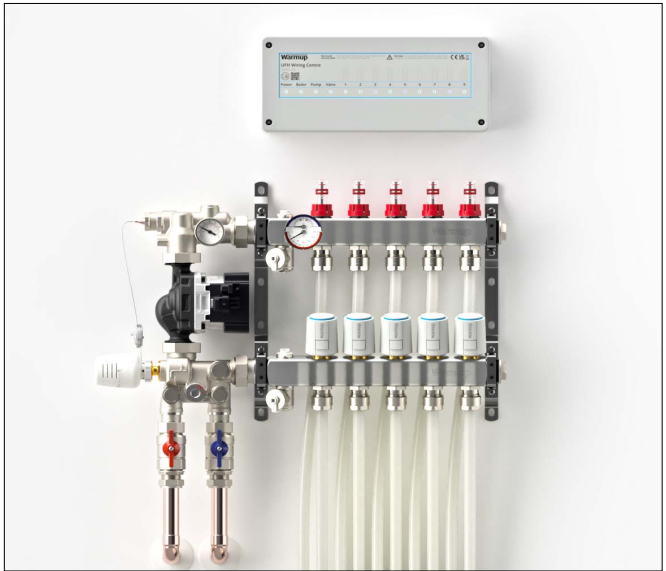

Identify a suitable mounting location for Wiring Centre.
The location should meet the following requirements;

The surface on to which it is to be mounted should be:

- i** Mounted where it will not be exposed to temperatures less than 0°C or greater than 45°C.
- i** In a dry, indoor environment with a relative humidity of no more than 70%.
- i** Close to the manifold, within cable reach of valve actuators and circulator on the manifold/mixing unit.

Step 2 - Assembly & mounting

The Wiring Centre can be either mounted directly on to a wall or mounted on a DIN rail. It is recommended that walls are assessed prior to drilling to reduce the risk of damaging existing services in the wall.

Wall mounting

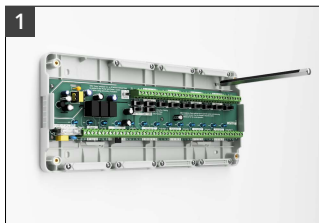

- Remove the front cover of the Wiring Centre and mark the screw positions on the mounting surface.



- Drill the pre-marked holes and insert a suitable wall plug (if required).

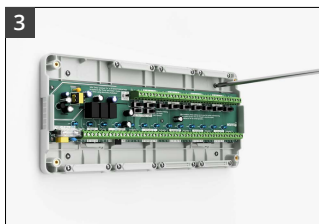

- Screw the Wiring Centre to the wall using M4x30mm screws.

DIN rail mounting

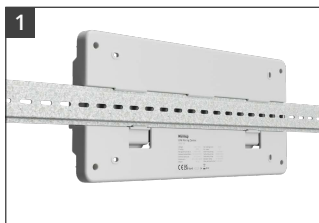

- Align the groove on the back of the Wiring Centre with the DIN rail, hook the Wiring Centre over the DIN rail and gently press the bottom in until it clicks into place.

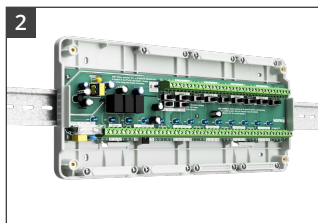

- To remove the Wiring Centre from the DIN rail, remove the front cover and gently pull on the two release clips.

Step 3 - Wiring - Power supply

- i** The Wiring Centre requires a 230V AC; 50Hz power supply.
- i** The power supply should not be livened until all electrical connections within the Wiring Centre and its interconnected devices have been made and their covers re-fitted.
- i** The Wiring Centre and connected devices must be supplied from a single point of isolation. The power supply can be taken directly from the systems switched fused spur or from the heat source if provisions exist.
- i** The Wiring Centre has a replaceable fuse located adjacent to the power supply terminals (F 2A L 250 VAC)

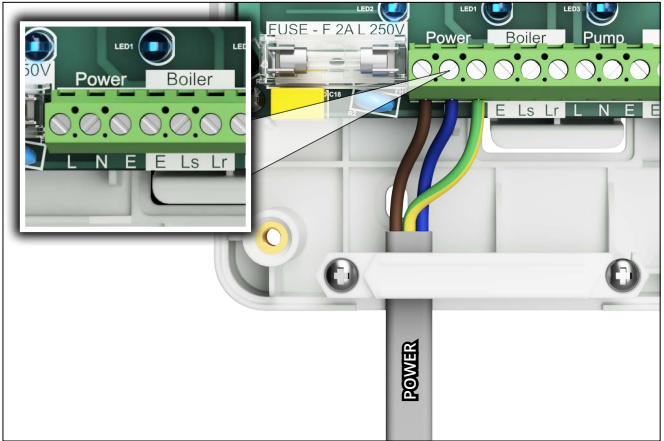

230V AC; 50Hz Power supply

L	= Live
N	= Neutral
E	= Earth

Step 3 - Wiring - Combined power supply & heat source

Connecting a heat source using a volt-free, 3A Switched e.g. Combi boiler

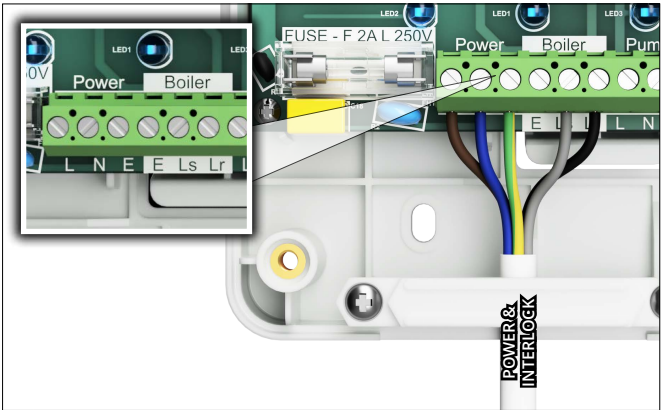

230V AC; 50Hz Power supply and interlock (5-core HR Flex)	
L	= Live
N	= Neutral
E	= Earth
Ls	= Live supply
Lr	= Live return (Switched live to heat source)

Connecting a heat source using 230V AC; 50Hz, 3A switched live e.g. System Boiler

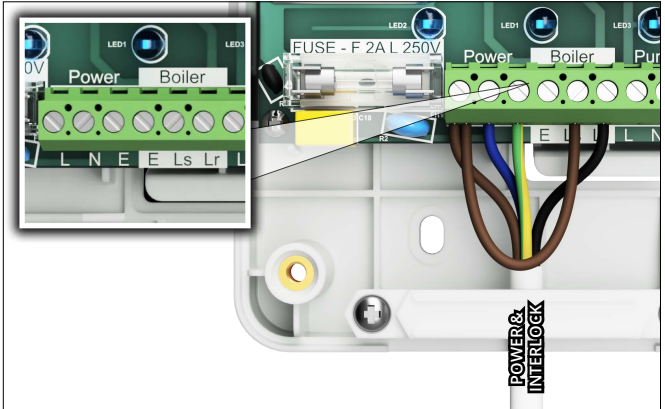

230V AC; 50Hz Power supply and interlock (4-core HR Flex)	
L	= Live
N	= Neutral
E	= Earth
Ls	= Live supply (Bridge wire)
Lr	= Live return (Switched live to heat source)

Step 3 - Wiring - Heat source

The heat source terminals provide a switched power supply. The heating interlock is enabled whenever a demand signal is received. It is recommended that the 90 second delayed start is enabled. This will allow the actuators to open before the heat source is energised.

 The maximum operating current when connecting a heat source using the Live return contact is 3 amps. For the Boiler circuit, make sure to use this product together with 3A circuit breaker in the upstream

Connecting a heat source using a volt-free, 3A Switched e.g. Combi boiler

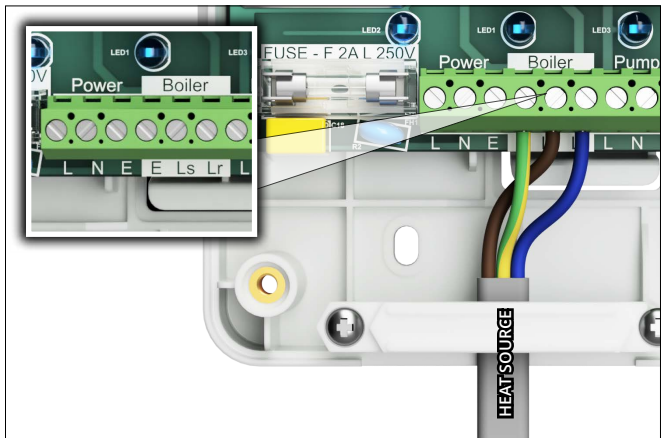

Heat source (Volt free)

E = Earth

Ls = Live supply

Lr = Live return (Switched live to heat source)

Connecting a heat source using 230V AC; 50Hz, 3A switched live e.g. System Boiler

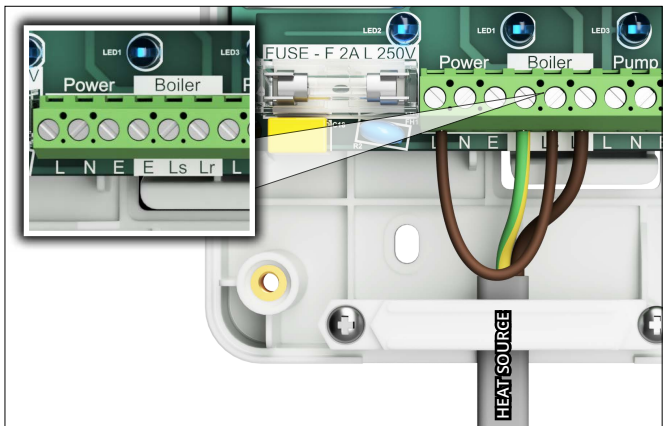

Heat source

E = Earth

Ls = Live supply (Bridge wire)

Lr = Live return (Switched live to heat source)

With 'Delay' switched 'On', a 90 second delayed start is applied to the 'Pump' and 'Boiler'. Enable this when using slow acting 'Actuators'.

Off On
Delay

Zone 1

Test

FW HW/F

LED1

LED3

LED4

LED6

Power

Boiler

Pump

Valve

Actuator 1



Step 3 - Wiring - Thermostat & actuators

i Up to 4 actuators can be connected to a single zone by connecting two into each pair of terminals.

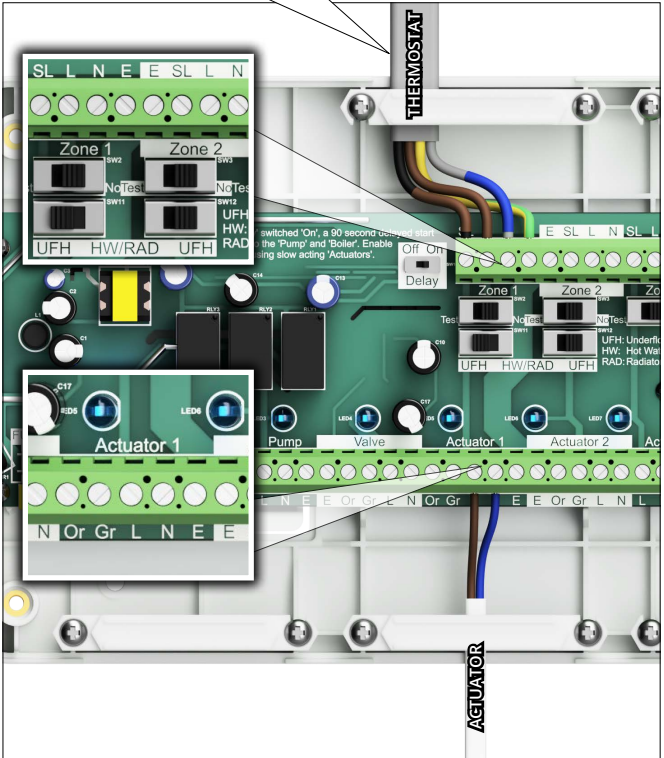

Thermostat connection on Wiring Centre

SL	=	Switched live
L	=	Live
N	=	Neutral
E	=	Earth

Actuators

L	=	Live
N	=	Neutral

Step 3 - Wiring - Thermostat & actuators



If a zone requires more than 4 actuators, two or more zones can be bridged together.

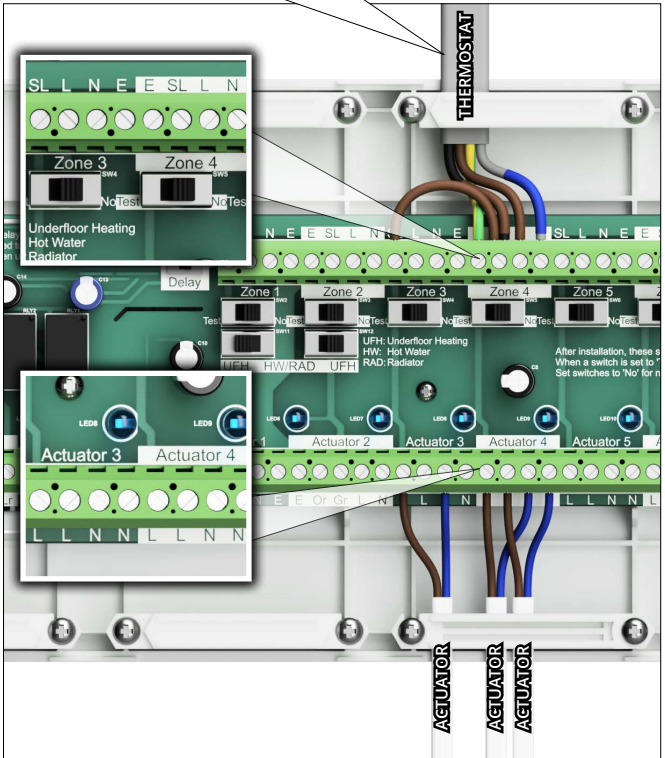

Thermostat connection on Wiring Centre

E	=	Earth
SL	=	Switched live & bridge wire
L	=	Live
N	=	Neutral

Actuators

L	=	Live
N	=	Neutral

Step 3 - Wiring - Circulator

The Wiring Centre provides a switched power supply out to a circulator that activates when any underfloor heating channel has demand.

- i** If a mixing unit is fitted to the controlled manifold, it should be this secondary circulator that is connected.
- i** If there is a dedicated primary circulator to this manifold or if the connected manifold is the only emitter on the heat source, then these terminals can provide power to that primary circulator.
- i** When enabled there is a 90 second delay on the circulator supply to allow the actuators to fully open. This can be disabled if required.

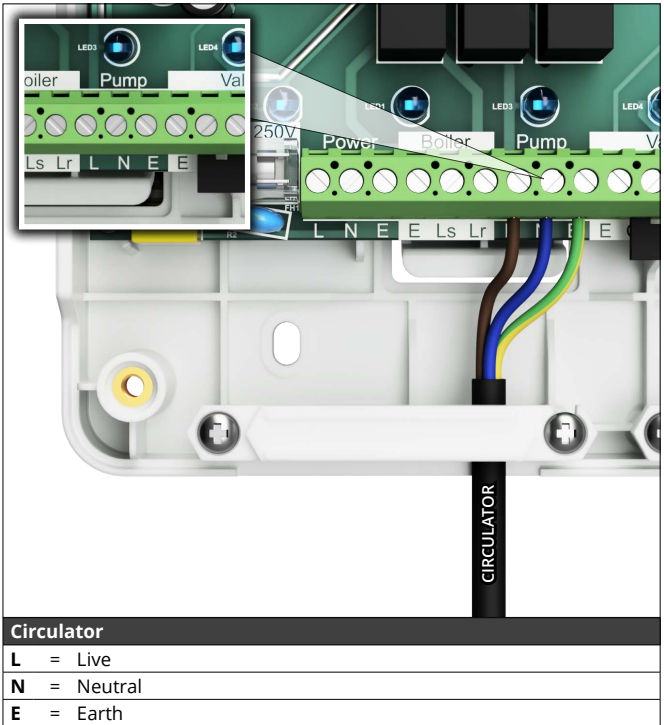

Step 3 - Wiring - UFH zone valve

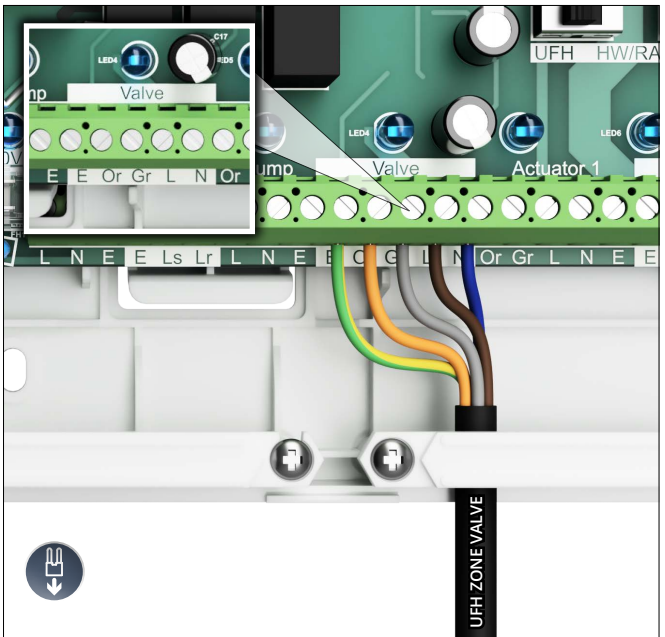

Zone valve

E	= Earth
Or	= Switched live to Wiring Centre
Gr	= Live
L	= Switched live to zone valve
N	= Neutral

- Where installed on the manifold supply, remove the bridge between Or and Gr.
- If a 2-Port motorised zone valve is used it must have an end switch and be connected as above.
- The underfloor heating circulator and heat source will be energised through the end switch. This is so that in the event of the valves failure, the heat source will not be activated by the Wiring Centre.

 2-Port motorised zone valves without an end switch must not be used

Step 3 - Wiring - Hot water

Zones 1 and/or 2 can be used to control hot water circuits by selecting HW/RAD on the mode switches. In this mode when the programmer and the cylinder thermostat call for heat, the zone valve will be energised. The heat source will be energised when the zone valve end switch closes.

i Delayed start function does not apply to hot water circuits.

i The UFH circulator and valve outputs are not energised by Zones 1 and/or 2 when they are set to HW/RAD.

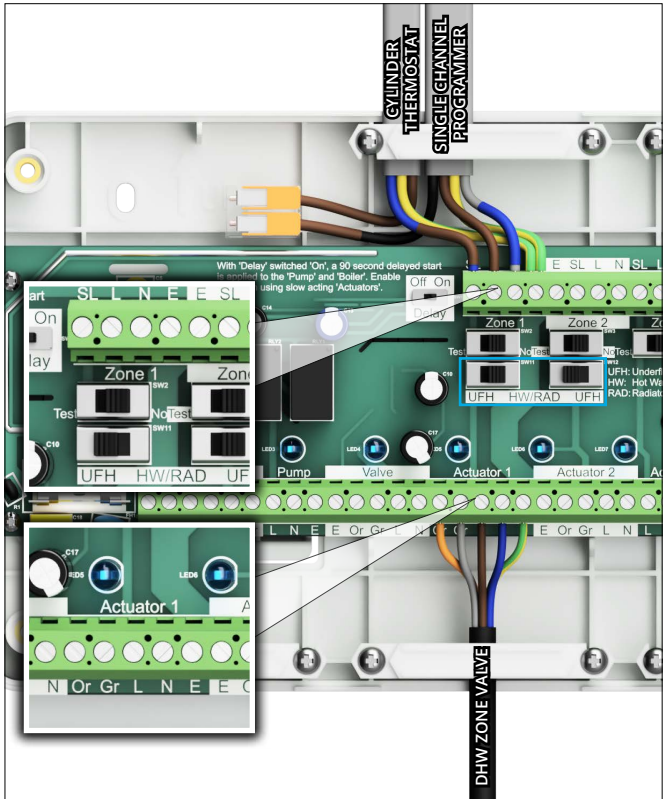

Programmer & cylinder thermostat connection on Wiring Centre

SL	=	Switched live
L	=	Live
N	=	Neutral
E	=	Earth

Programmer & cylinder thermostat connection on junction block



SL	=	Switched live in from programmer
SL	=	Switched live out to cylinder thermostat

Zone valve (Hot water)

Or	=	Switched live to Wiring Centre
Gr	=	Live
L	=	Switched live to zone valve
N	=	Neutral
E	=	Earth

Step 3 - Wiring - Radiators

Zones 1 and/or 2 can be used to control conventional radiator circuits by selecting HW/RAD on the mode switches. In this mode when the radiator thermostat calls for heat, the zone valve will be energised. The heat source will be energised when the zone valve end switch closes.

-  Delayed start function does not apply to radiator circuits.
-  The UFH circulator and valve outputs are not energised by Zones 1 and/or 2 when they are set to HW/RAD.

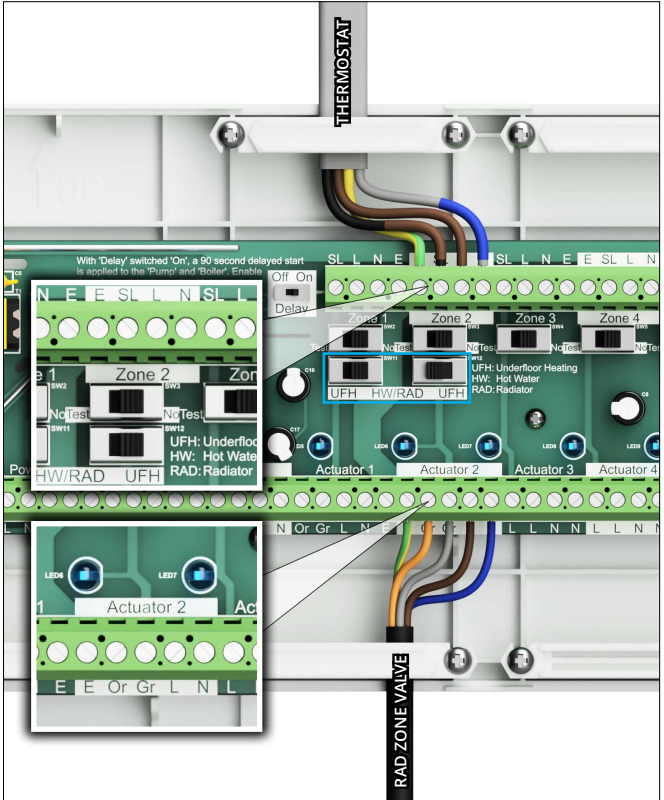

Thermostat connection on Wiring Centre

E	=	Earth
SL	=	Switched live
L	=	Live
N	=	Neutral

Zone valve (Radiators)

E	=	Earth
Or	=	Switched live to Wiring Centre
Gr	=	Live
L	=	Switched live to zone valve
N	=	Neutral

Wiring schematic - Typical installation

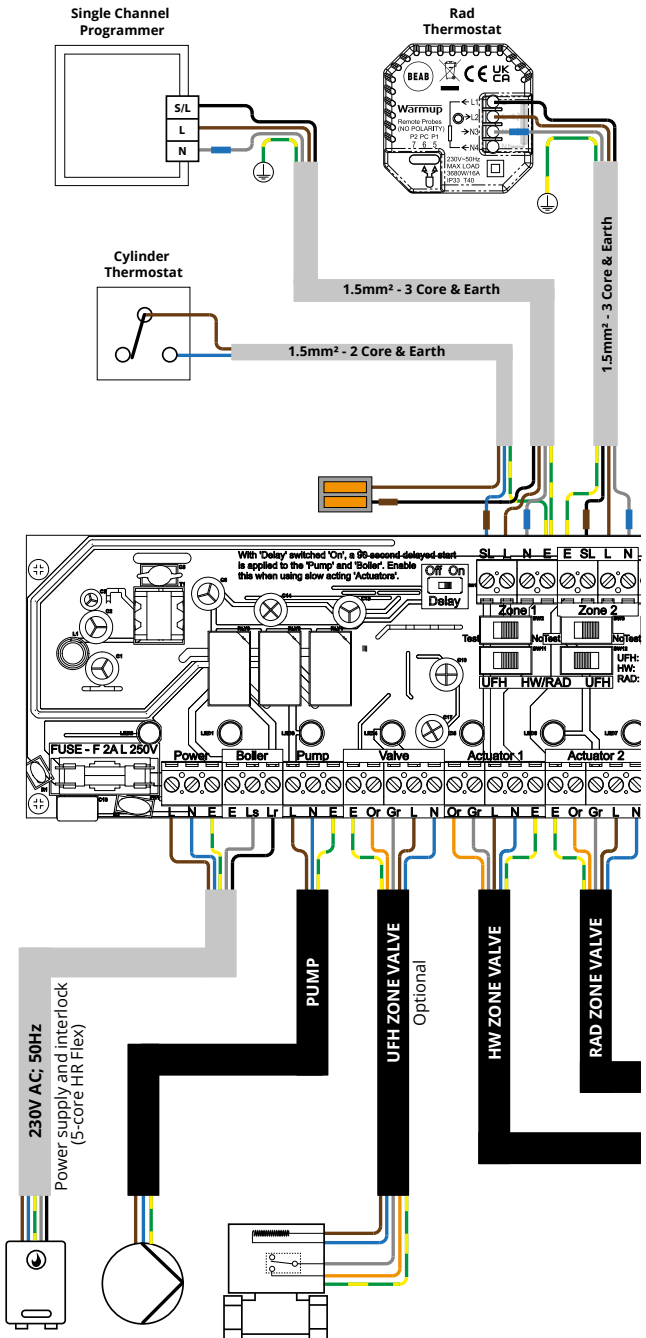

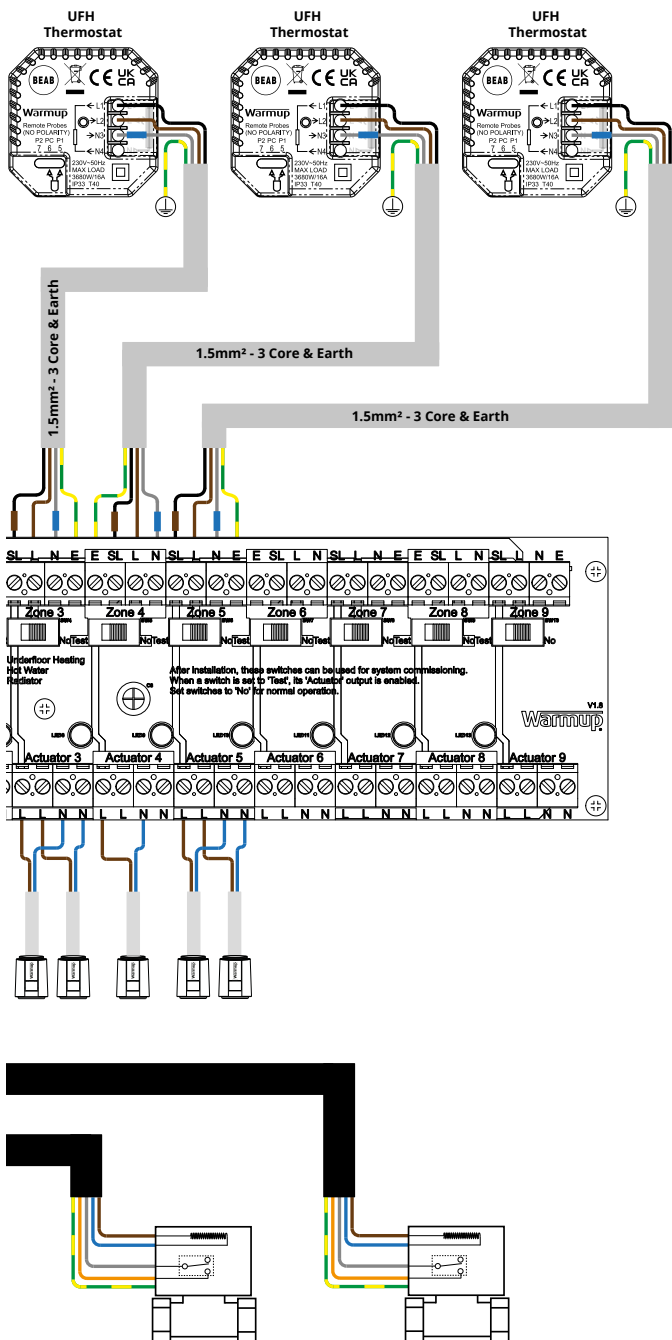

Plumbing schematic - Typical installation

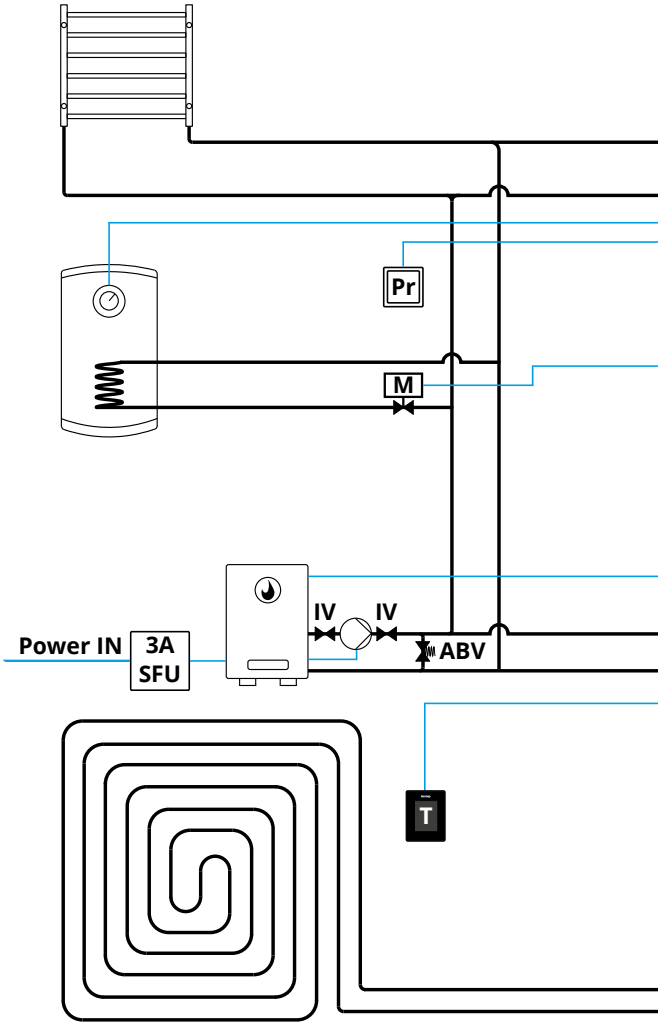

Legend



Heated towel rail



Heat source



Cylinder thermostat



Isolation Valve



Hot water cylinder



Circulator



3A Switched Fuse Spur



Hot water programmer



Underfloor heating



Motorised zone valve

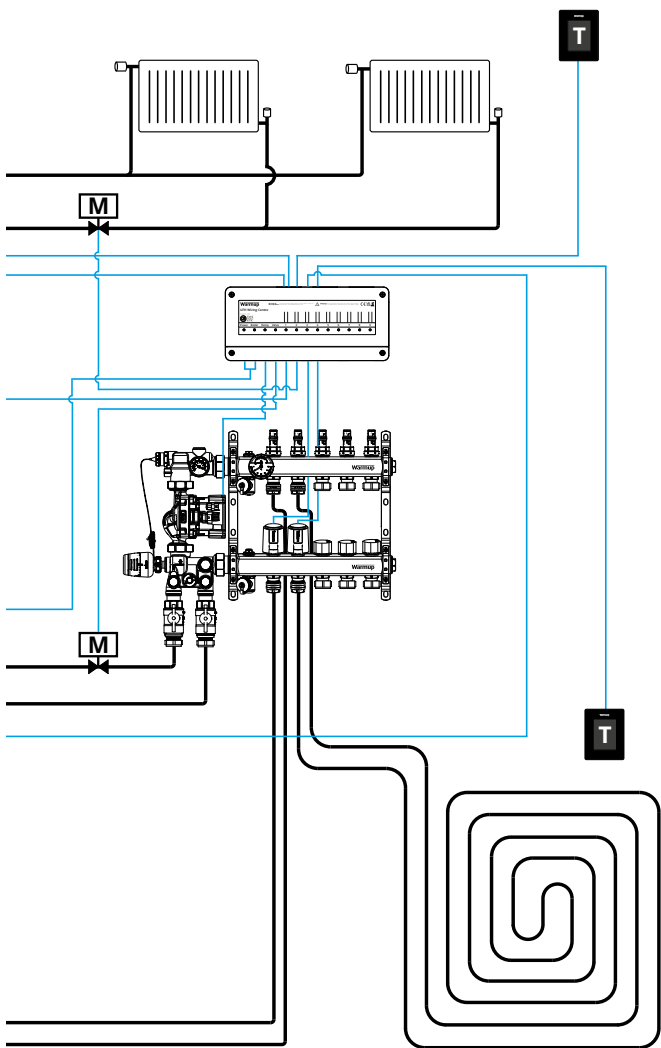

ABV



Automatic by-pass valve



Thermostat



Radiators



UFH Wiring centre (WWC-09)

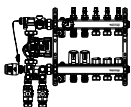

S3 Manifold, mixing unit and isolation valves

Troubleshooting

ISSUE 1 - Power LED not activated

Must completed by a qualified and competent electrician

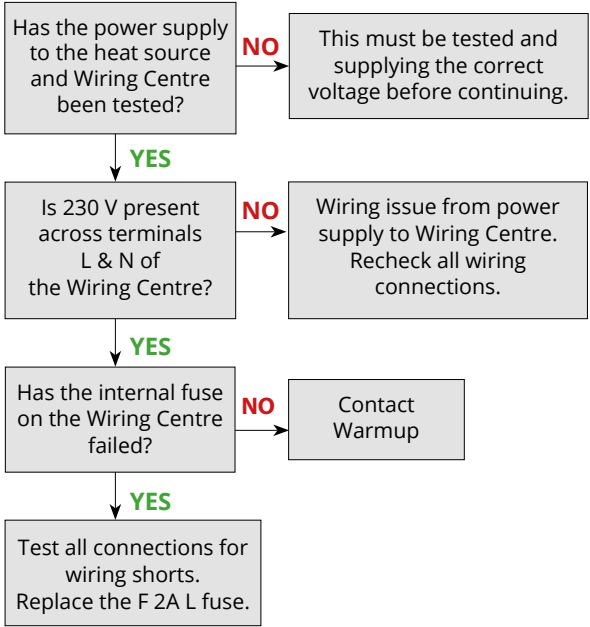

Troubleshooting

ISSUE 2 - Thermostat does not have power

Must be completed by a qualified and competent electrician



Ensure issue 1 has been ruled out first

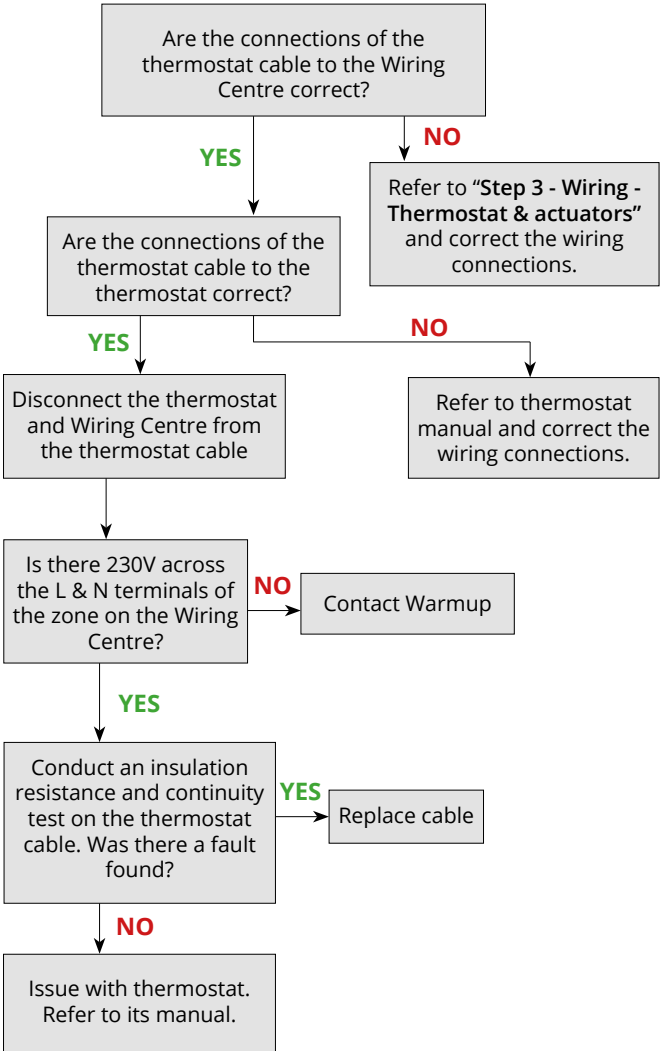

Troubleshooting

ISSUE 3 - Zone LED(s) not activating

Must be completed by a qualified and competent electrician.

i Ensure issues 1-2 have been ruled out first

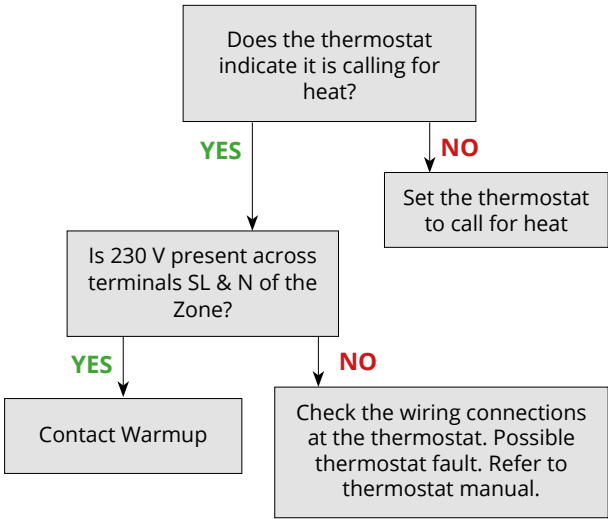

Troubleshooting

ISSUE 4 - Zone LED(s) always active

Must completed by a qualified and competent electrician.



Ensure issues 1-3 have been ruled out first

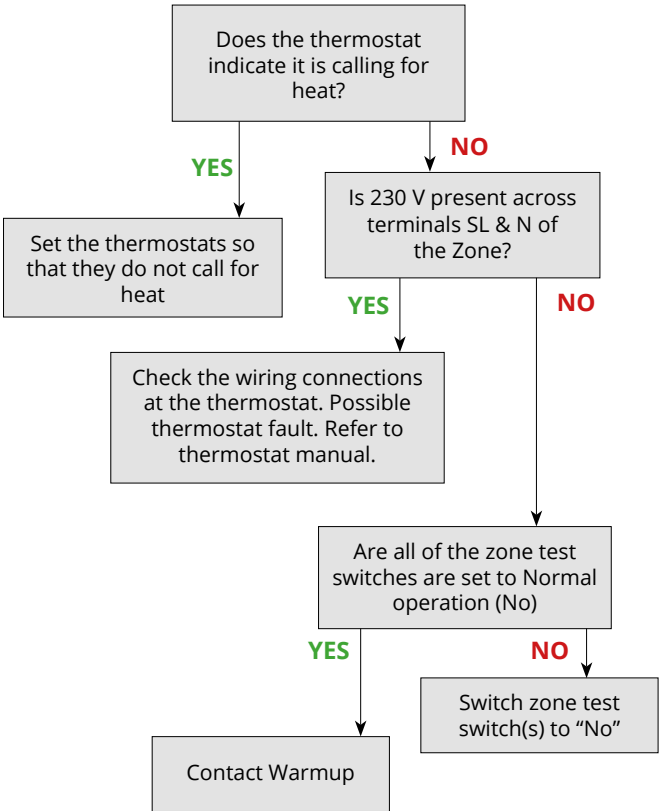

Troubleshooting

ISSUE 5 - Actuator(s) or HW/RAD zone valve not activating
Must completed by a qualified and competent electrician.



Ensure issues 1-4 have been ruled out first

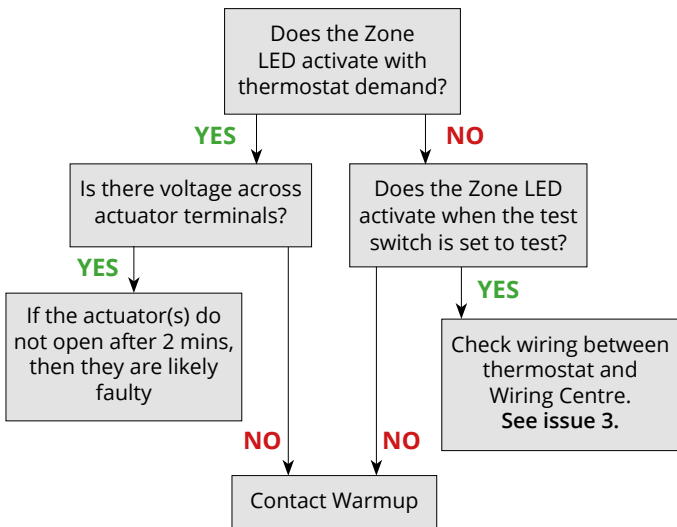

Troubleshooting

ISSUE 6 - Valve LED not activating when Zone LED(s) do
Must completed by a qualified and competent electrician.



Ensure issues 1-5 have been ruled out first

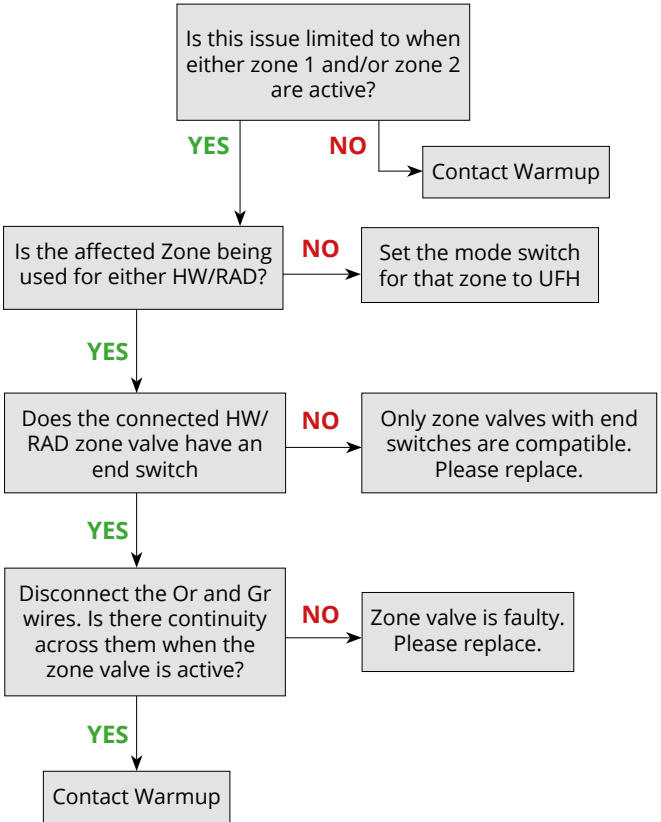

Troubleshooting

ISSUE 7 - Boiler and Pump LED's not activating Must completed by a qualified and competent electrician.

 Ensure issues 1-6 have been ruled out first

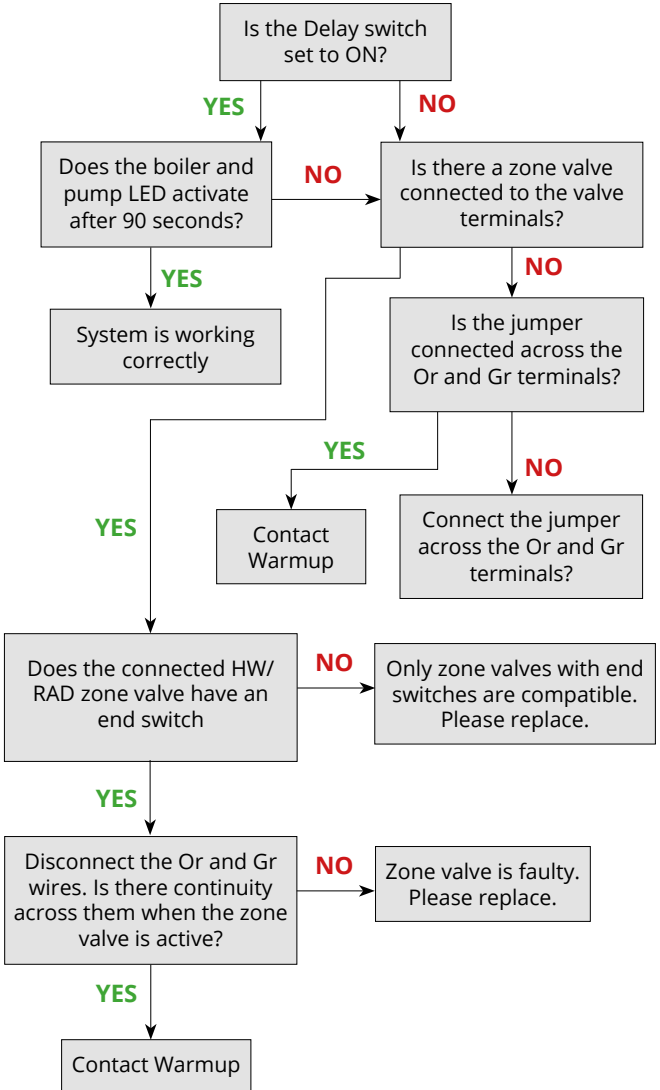

ISSUE 1 - The Wiring Centre fuse blows as soon it activates

SOLUTION

- | | |
|---|--|
| 1 | Check all wiring is connected correctly |
| 2 | Check the power supply to ensure there are no short circuits across any of the terminals |
| 3 | Ensure a F 2A L 250VAC fuse is fitted |
| 4 | Check all thermostat connections for short circuits |

ISSUE 2 - The Wiring Centre fuse blows as soon as any zone activates

SOLUTION

- | | |
|---|--|
| 1 | Check the wiring for the circulator is connected correctly |
| 2 | Check the wiring for the heat source is connected correctly |
| 3 | Check the wiring for the zone valve (if fitted) is connected correctly |
| 4 | Check all wiring for any short circuits |

ISSUE 3 - The Wiring Centre fuse blows when only one zone activates

SOLUTION

- | | |
|---|--|
| 1 | Check the wiring to the thermostat for a short circuit |
| 2 | Check the wiring to the zone actuators for a short circuit |

Technical specifications

UFH Wiring Centre (WWC-09)	
Operating voltage	230V AC; 50Hz
Max. total load	2A resistive
Supply overload protection	3A (Use external 3A MCB's, RCBO's or fuses for this purpose)
Fuse	F 2A L 250V 5x20mm
Classification of control according to protection against electric shock	Class I
No. of cycles of actuation (M)	10000
Type of disconnection	Micro-disconnection
Additional features of actions	1.B
Pollution degree	2
Glow wire temperature	550 / 850°C
Rated impulse voltage	4KV
Period of electric stress across insulating parts	Long period
IP rating	IP20
Operating temperature	0 - 45°C, T45
Wire size	1.0 - 2.5mm ²
Max. number of zones	9
Max. of hybrid zones	2 (HW/RADS)
Max. Load Outputs	Boiler - 3A Resistive (Supply MUST be protected by 3A MCB/RCBO)
	Pump - 0.6A Resistive (0.6A inductive resistance of the motor)
	Valve - 0.2A Resistive
	Actuators - 0.1A Resistive
DIN-rail mounting	Yes
Commissioning switches	9
Delayed start	90 seconds; switchable

Warmup plc ■ 704 Tudor Estate ■ Abbey Road ■ London ■ NW10 7UW ■ UK
Warmup GmbH ■ Ottostraße 3 ■ 27793 Wildeshausen ■ DE

Instructions for Disposal

Do not dispose of the device with regular domestic waste!
Electronic equipment must be disposed of at local collection points for waste electronic equipment in compliance with the Waste Electrical and Electronic Equipment Directive.



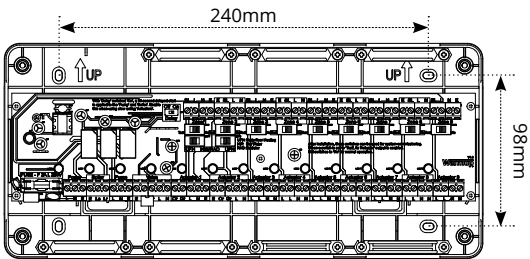
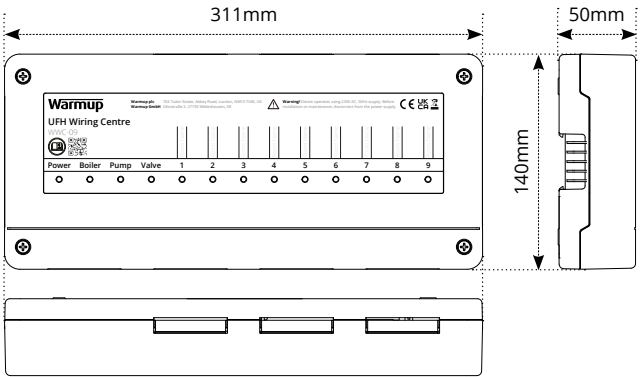

Warranty

Warmup plc limited warranty - UFH Wiring Centre - WWC-09



Warmup plc warrants this product, to be free from defects in the workmanship or materials, under normal use and service, for a period of twelve (12) years from the date of purchase by the consumer when installed with Warmup thermostats, actuators and manifold mixing unit where applicable.

If at any time during the warranty period the product is determined to be defective, Warmup shall repair or replace it, at Warmup's option. If the product is defective, please either;

Return it, with a bill of sale or other dated proof of purchase, to the place from which you purchased it, or

Contact Warmup. Warmup will determine whether the product should be returned or replaced.

The twelve (12) year warranty only applies if the product is registered with Warmup within 30 days after purchase. Registration can be completed online at www.warmup.co.uk

This warranty does not cover removal or re-installation costs and shall not apply if it is shown by Warmup that the defect or malfunction was caused by failure to follow the instruction manuals, incorrect installation or damage which occurred while the product was in the possession of a consumer. Warmup's sole responsibility shall be to repair or replace the product within the terms stated above. If the WWC-09 is installed with any non-Warmup thermostats, actuators or manifold mixing unit a three (3) year warranty will apply.

WARMUP SHALL NOT BE LIABLE FOR ANY LOSS OR DAMAGE OF ANY KIND, INCLUDING ANY INCIDENTAL OR CONSEQUENTIAL DAMAGES RESULTING, DIRECTLY OR INDIRECTLY, FROM ANY BREACH OF ANY WARRANTY, EXPRESS OR IMPLIED, OR ANY OTHER FAILURE OF THIS PRODUCT. THIS WARRANTY IS THE ONLY EXPRESS WARRANTY WARMUP MAKES ON THIS PRODUCT. THE DURATION OF ANY IMPLIED WARRANTIES, INCLUDING THE WARRANTIES OF MERCHANTABILITY AND FITNESS FOR A PARTICULAR PURPOSE, IS HEREBY LIMITED TO THE TWELVE-YEAR DURATION OF THIS WARRANTY.

This warranty does not affect your statutory rights.



Warmup plc

www.warmup.co.uk

uk@warmup.com

T: 0345 345 2288

F: 0345 345 2299



**Please scan the QR code to provide
feedback on your installation**

Warmup

The WARMUP word and associated logos are trade marks.
© Warmup Plc. 2024 – Regd.™ Nos. 1257724, 4409934, 4409926,
5265707. E & OE.

Warmup plc ■ 704 Tudor Estate ■ Abbey Road ■ London ■ NW10 7UW ■ UK

Warmup GmbH ■ Ottostraße 3 ■ 27793 Wildeshausen ■ DE

Warmup - IM - WWC-09 - V1.7 2024-02-22_EN